

Luminescence and Related Spectroscopies of Semiconductors and Heterostructures

(mostly photoluminescence, and bulk)

Mike Thewalt, Dept. of Physics
Simon Fraser University
Burnaby, BC V5A 1S6, Canada

Tutorial Session 2 – Sunday July 25, 2004

ICPS-27, Flagstaff, AZ, July 26-30, 2004

Outline

- technical and equipment considerations
- brief introduction to semiconductor physics, optical transitions
- characterization examples for indirect band gap: Silicon
- examples for direct band gap: high purity GaAs
 - lower quality and bulk GaAs
 - magnetophotoluminescence
 - narrow gap InAs and InSb
- discrete donor-acceptor-pair band in isotopically enriched GaP

This presentation does *not* contain comprehensive data on the huge range of the subject covered here – for materials parameters, transition energies, further specific references see the appropriate volume of:

Landolt-Börnstein series (Springer, Berlin)

Technical and equipment issues

- excitation – lasers, tunable and fixed frequency
- luminescence collection and focussing – lenses vs. mirrors
- sample cooling – He immersion, Varitemp, cold finger
- spectroscopy – dispersive vs. Fourier transform (FT)

Excitation: Since the overall subject is photoluminescence spectroscopy, this implies optical excitation. Other excitation mechanisms are possible, such as the use of high energy electrons for excitation in cathodoluminescence, which may have advantages for exciting very wide band gap materials, or in imaging.

For nonresonant excitation, visible lasers (Ar-ion, doubled Nd) are generally used, since the visible collimated beam makes alignment trivial. Here the high spectral purity of lasers is not utilized, but the extraneous longer wavelength components are weak and easily removed. For resonant excitation, tunable sources are needed, Ti-sapphire being the most common, but with nonlinear sources, and free electron lasers, covering a much broader spectral region.

Luminescence collection: The collection of luminescence from the sample and focusing into the spectrometer may be accomplished with either lenses or mirrors (off-axis paraboloids or ellipsoids).

Mirrors – have very wide spectral coverage and are completely achromatic (aligned in the visible = aligned at all frequencies), however, proper alignment and tight focusing with off-axis mirrors is tricky

Lenses – can be simpler and less expensive to set up, but are not achromatic, and function over a limited spectral region.

Sample cooling: Most (but not all) semiconductor characterization is done at cryogenic temperatures, due to the small binding energies of the states involved. There are several techniques for cooling the sample.

He immersion cryostat – the preferred technique when the desired temperature is 4.2K or below, and the temperature needs to be very accurately known and maintained (i.e.: Si PL). It also allows for completely strain free (loose) sample mounting, important for high resolution studies. Samples can be changed rapidly.

Varitemp cryostat – Since these can be operated with liquid He in the tail, they have the advantages of the immersion cryostat for 4.2K and below, at the cost of slightly lower efficiency and ease of operation. They offer the ability to operate from 4.2K to room temperature in the flowing He gas, but then the actual sample temperature (vs. the sample holder temperature) becomes an issue, particularly when significant excitation power falls on the sample, and when the sample is small. To avoid this, the sample must be thermally anchored to the metal sample holder, but then great care needs to be taken to avoid thermal strains.

Cold finger cryostats – are often used when liquid He is not available, so closed cycle refrigerators must be used. Since the sample is in vacuum, good thermal contact between the sample and the cold finger becomes essential, and the avoidance of thermal strains is a severe problem. Small samples can be anchored to large pieces of the same material, which can be anchored to the cold finger far from the sample. Even so, with moderate excitation powers the sample temperature may be surprisingly higher than that of the cold finger. Sample changes also can be more problematic.

Windows: can be considered to be either part of the luminescence collection path, or the sample cooling cryostat. They must pass all wavelengths of interest, withstand atmospheric pressure, and in the cryostat, be able to withstand repeated cycling from room temperature to He temperature and back. Some standard materials are:

Silica – inexpensive, available in large sizes, ~200nm to 2000nm

Sapphire – relatively inexpensive, very strong, can be birefringent, 200nm to 5500nm

CaF₂ – relatively inexpensive, 200nm to 8500nm, not liquid He

ZnSe – relatively expensive, 600nm to 18,000nm, liquid He ok

Polyethylene (thick) – transparent below 1000 cm⁻¹, not liquid He, no visible access

Polypropylene (thin) – transparent below 1000 cm⁻¹, liquid He ok, visible access, fragile

Mylar (thin) – as polypropylene, but with some absorption bands

Diamond – the promise of UV to FIR transparency, strength, but\$\$

Dispersive (diffraction grating) spectrometers

- can be less expensive
- can have higher sensitivity, at moderate resolution, with photon counting detectors or parallel detectors (CCD's)
- better suited to transient, lifetime studies
- inherent rejection of unwanted wavelengths (esp. double and triple)
- only moderate resolution possible
- need calibration for high accuracy
- lack versatility – high and low res., wide coverage, in one instrument

or single ↓

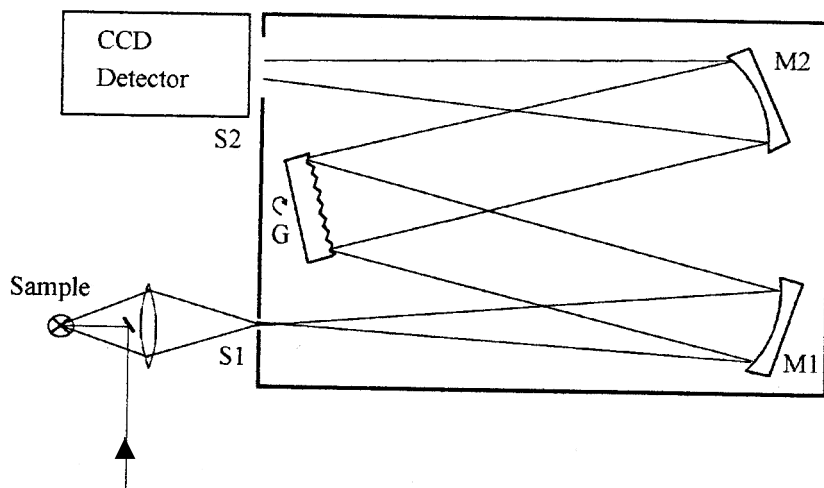

double spectrometer

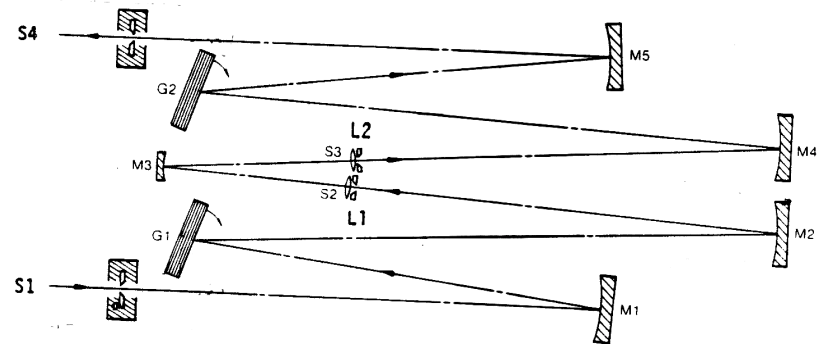

Fourier transform spectroscopy – Michelson Interferometers

- high resolution and high inherent energy accuracy
- wide spectral coverage – UV to FIR
- higher sensitivity, at all resolutions, at longer wavelengths
- a single instrument is well suited to both high and low resolution work

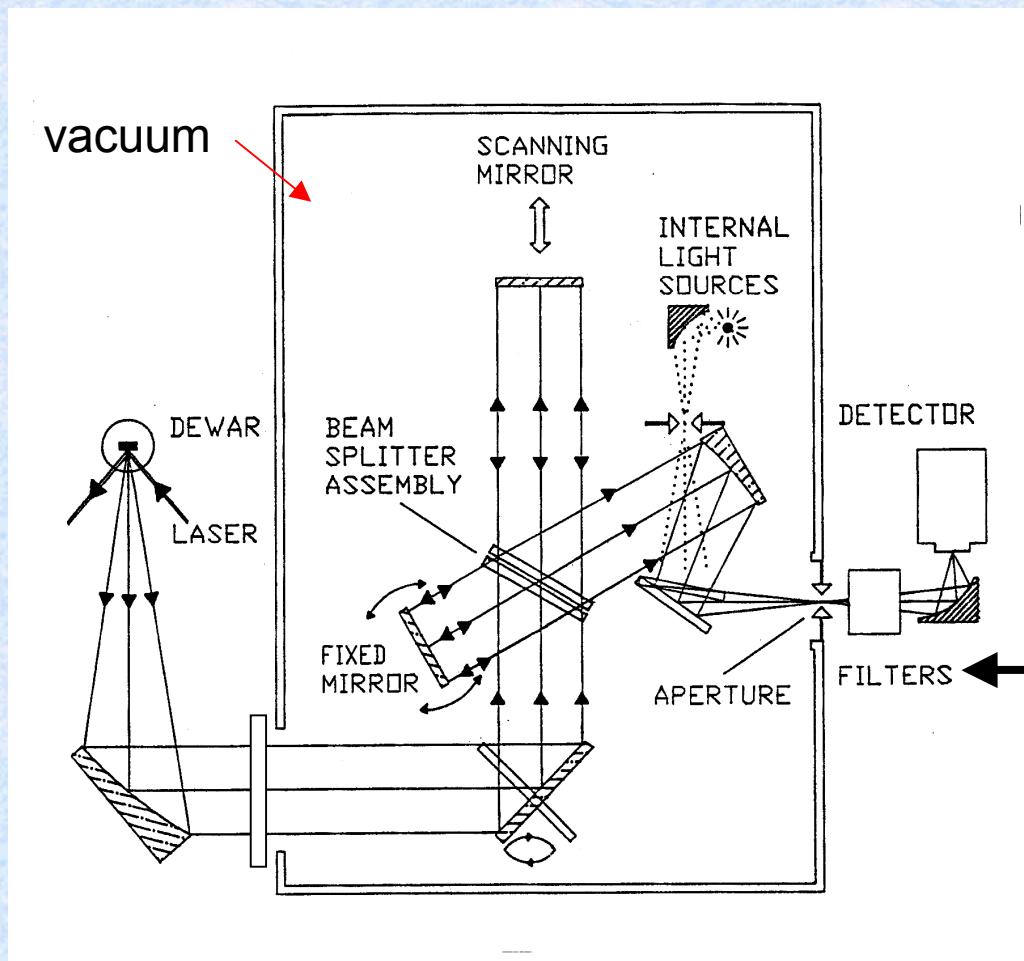

- no collection time penalty for very wide spectral scans
- large collection aperture at a given resolution; high throughput
- no rejection of unwanted wavelengths; the detector filter is crucial

- for nonresonant exc., glass long pass filters ok
- for resonant and Raman, need narrow bandpass or holographic laser reject filter

IMPURITIES (doping) - donors and acceptors

in silicon:
(valence 4)

one extra valence electron – donor – phosphorus
one missing valence electron – acceptor – boron

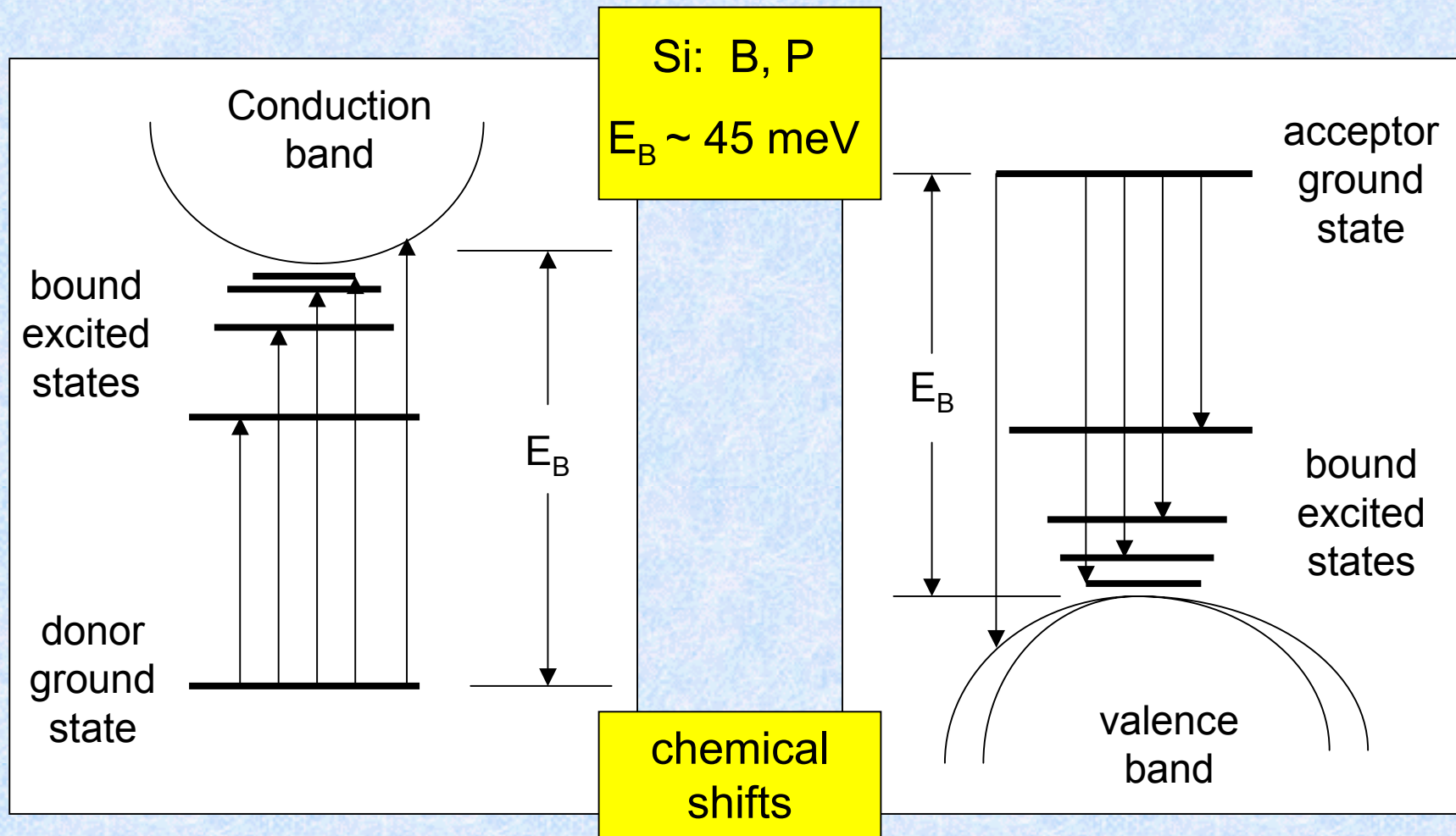

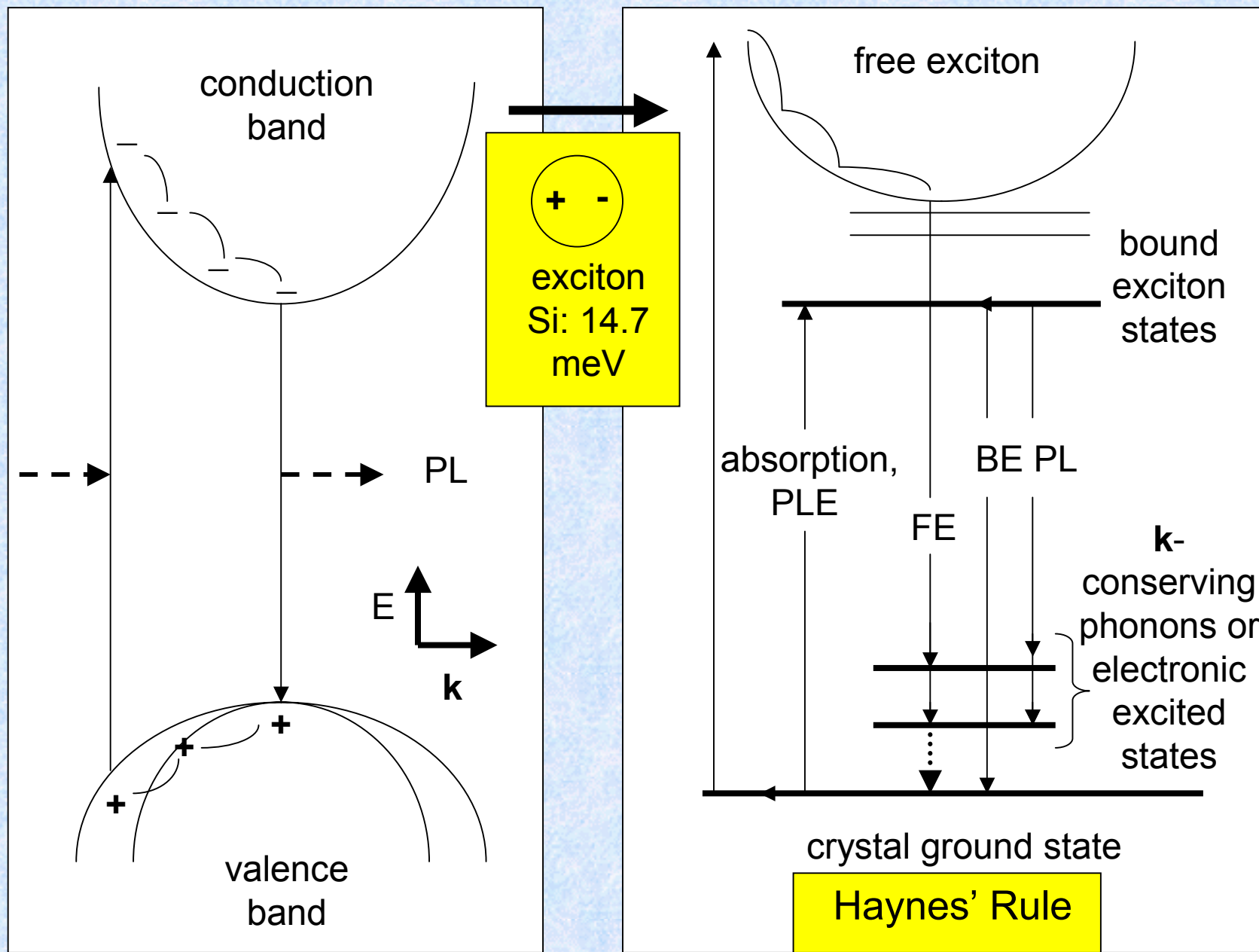

J. R. Haynes, Phys. Rev. Lett. 4, 361 (1960)

Excitons in direct gap vs. indirect gap semiconductors

small m_e^*

small donor,
donor BE E_b

short lifetimes

strong absorption

exciton-polariton
effect

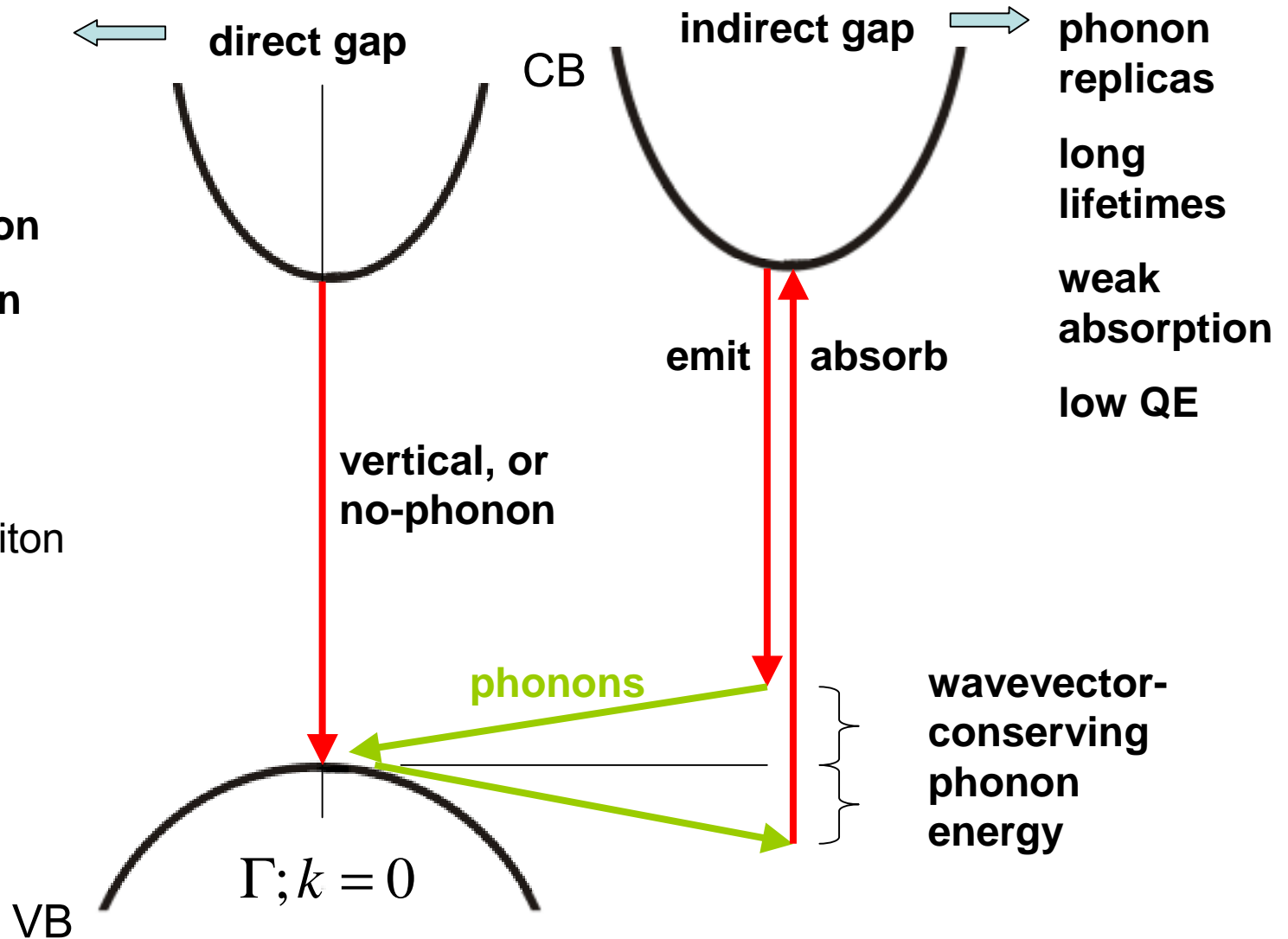
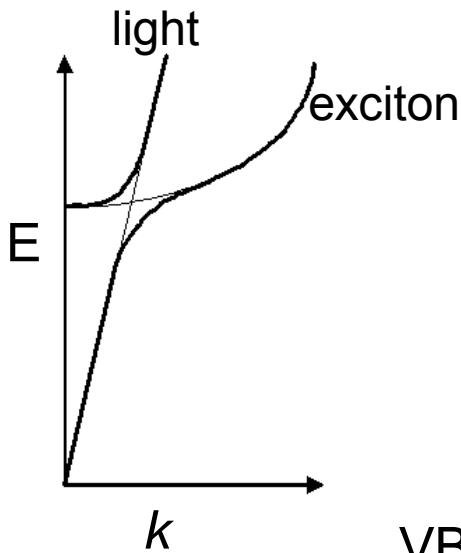

phonon replicas

long lifetimes

weak absorption

low QE

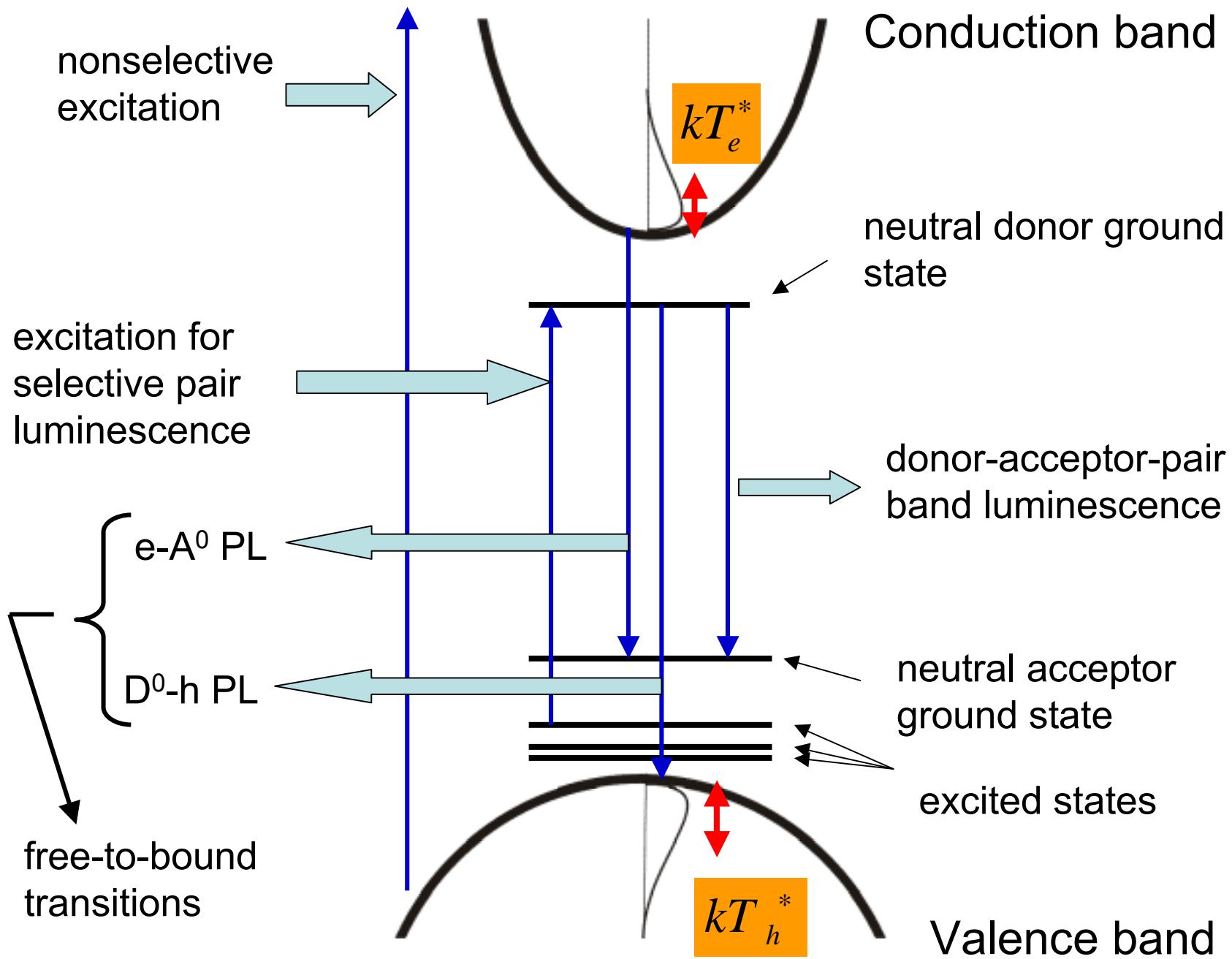

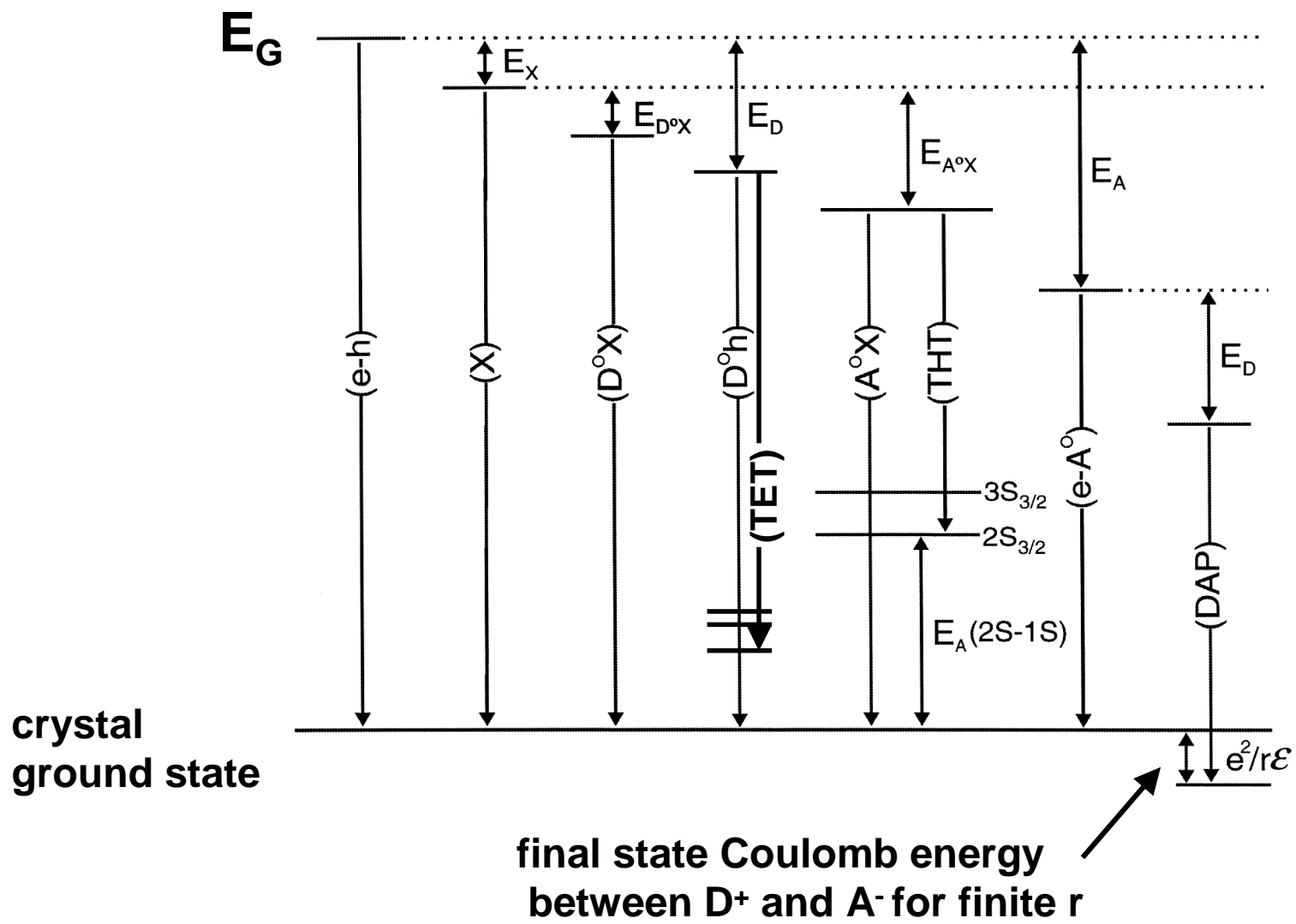

Si PL: quantitative donor and acceptor characterization

- indirect band gap: strong free exciton (FE) phonon replicas with intensities directly proportional to FE concentration
- no reabsorption problems (very transparent at PL energies)
- efficient photoneutralization at very low excitation levels
- all shallow donor and acceptor chemical shifts are large enough to spectrally resolve the different species in the principal BE no-phonon (np) transitions
- the most common donor (P) and acceptor (B) are even well-resolved in the strong TO phonon replica
- 0.5 cm^{-1} resolution is adequate for characterization purposes
- the existence of the condensed plasma electron-hole-droplet (EHD) phase puts a soft upper bound on the FE concentration, making the results at high excitation relatively excitation level independent
- donor and acceptor concentrations are a reproducible, linear function of the relevant BE/FE intensity ratio (Michio Tajima, Appl. Phys. Lett. 32, 719 (1978))

Typical PL spectrum of medium purity Si (^{30}Si , but never mind)

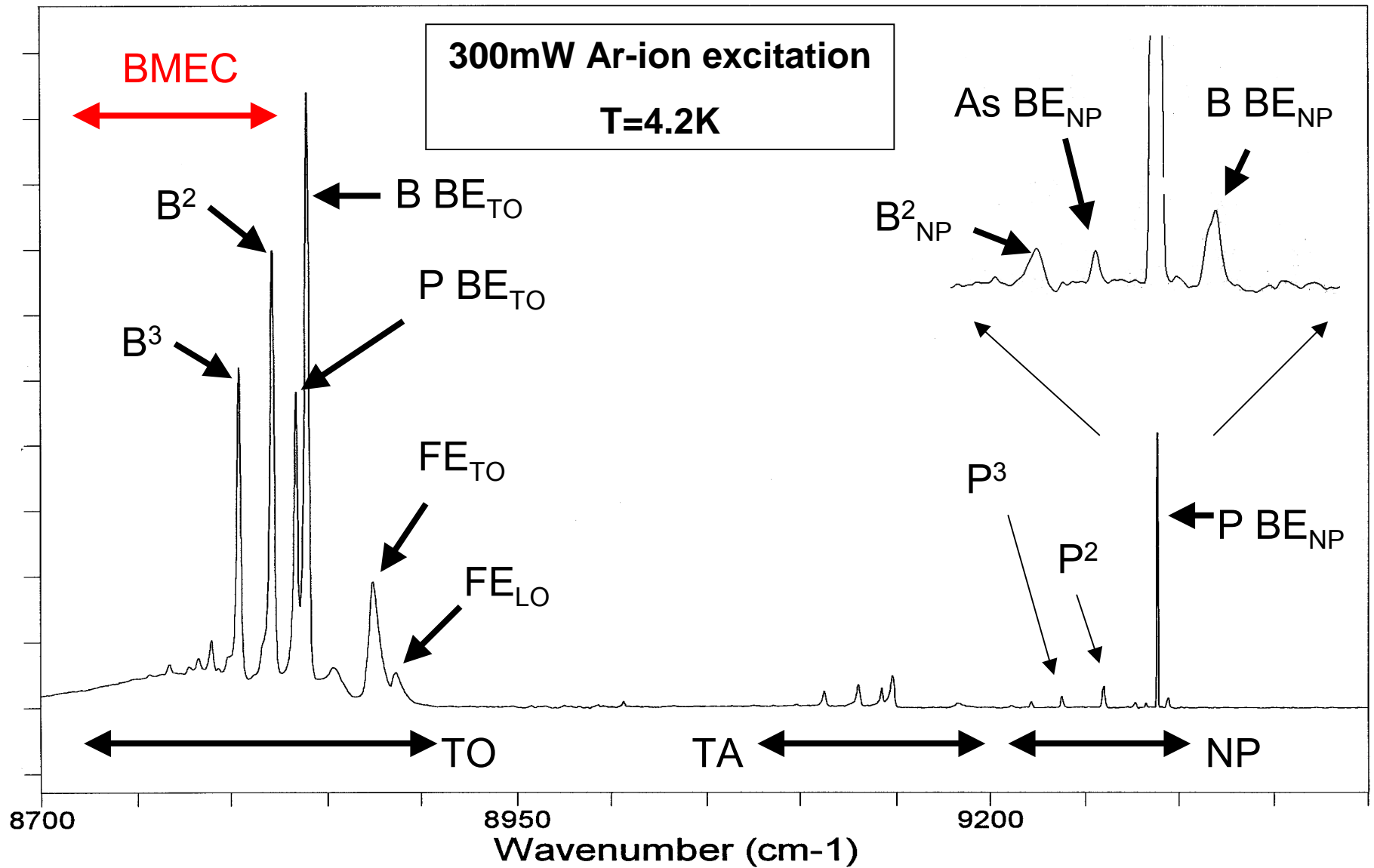

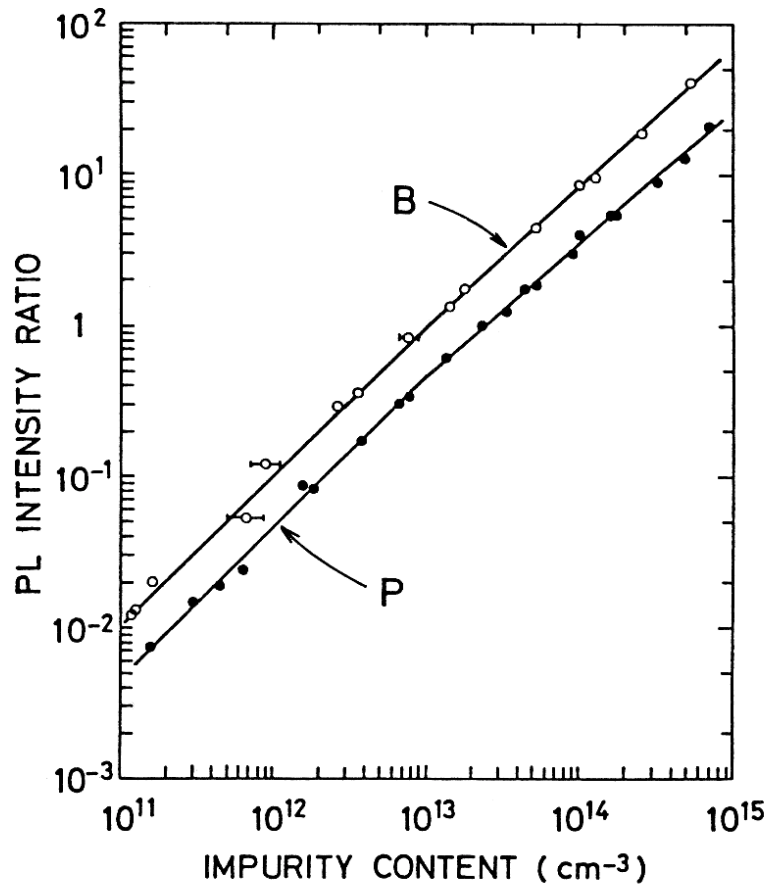

BE_{TO} to FE_{TO} ratio

M. Tajima et al., Semiconductor Silicon 1981 (Electrochemical Soc., 1981) p. 72.
 Also Al, As: M. Tajima et al., J. Electrochem. Soc. **137**, 3544 (1990)

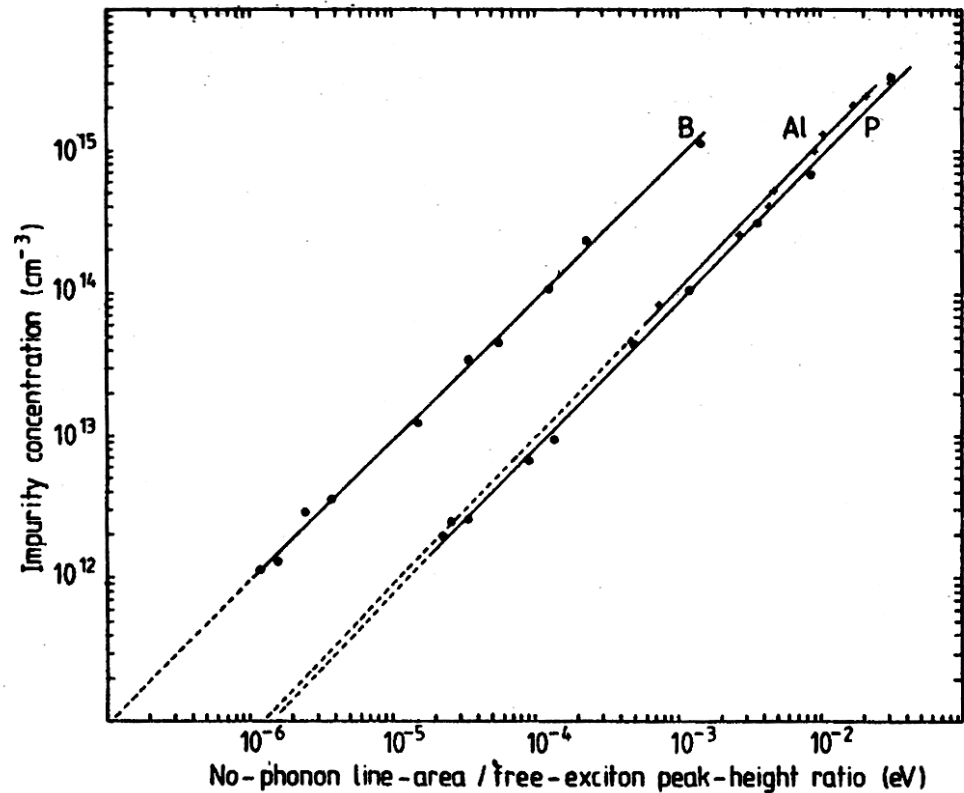

BE_{NP} to FE_{TO} ratio

(also first to publish FT results)

P. McLColley and E. C. Lightowlers, Semicond. Science and Technol. 2, 157 (1987)

ASTM F1389

problems with the standard technique for superpure Si

- using high excitation, extraneous transitions mask the bound excitons
- simpler at low excitation, but low signal? Bulk excitation at 1047nm (Nd:YLF) provides low excitation density yet strong signals
- other benefits: excitation level independence, stronger BE

I. Broussell et al., J. Appl. Phys. 92, 5913 (2002))

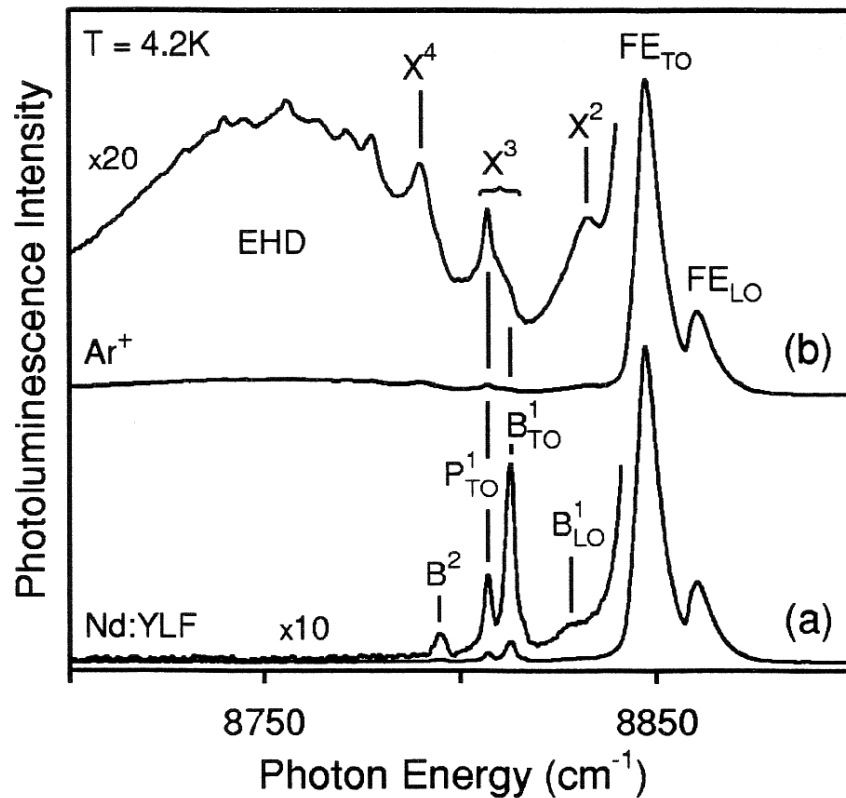

$X^n??$

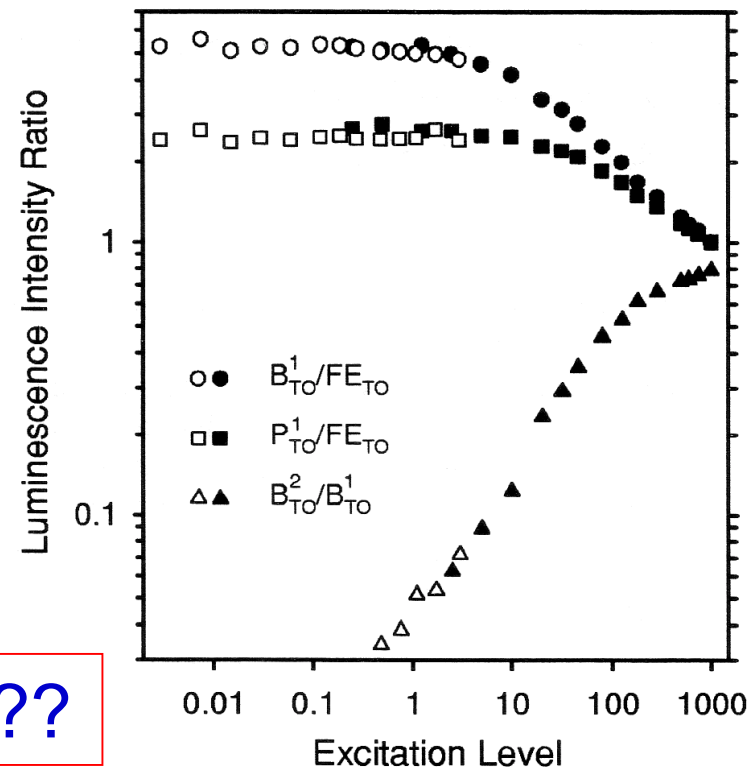

Polyexcitons – predicted by C. Kittel in 1972

just as $H + H \rightarrow H_2$, $X + X \rightarrow X_2$, but it needn't stop there thanks to the extra degeneracy: $X_2 + X \rightarrow X_3$, $X_3 + X \rightarrow X_4$ etc.

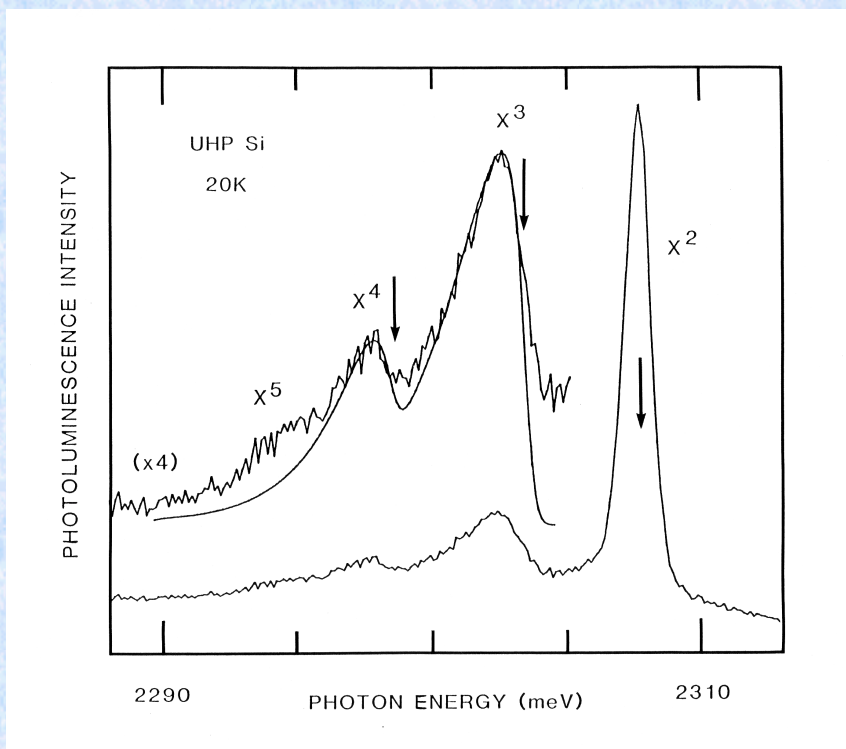

'green' luminescence at $2xE_g$
PRL 59, 2899 (1987)

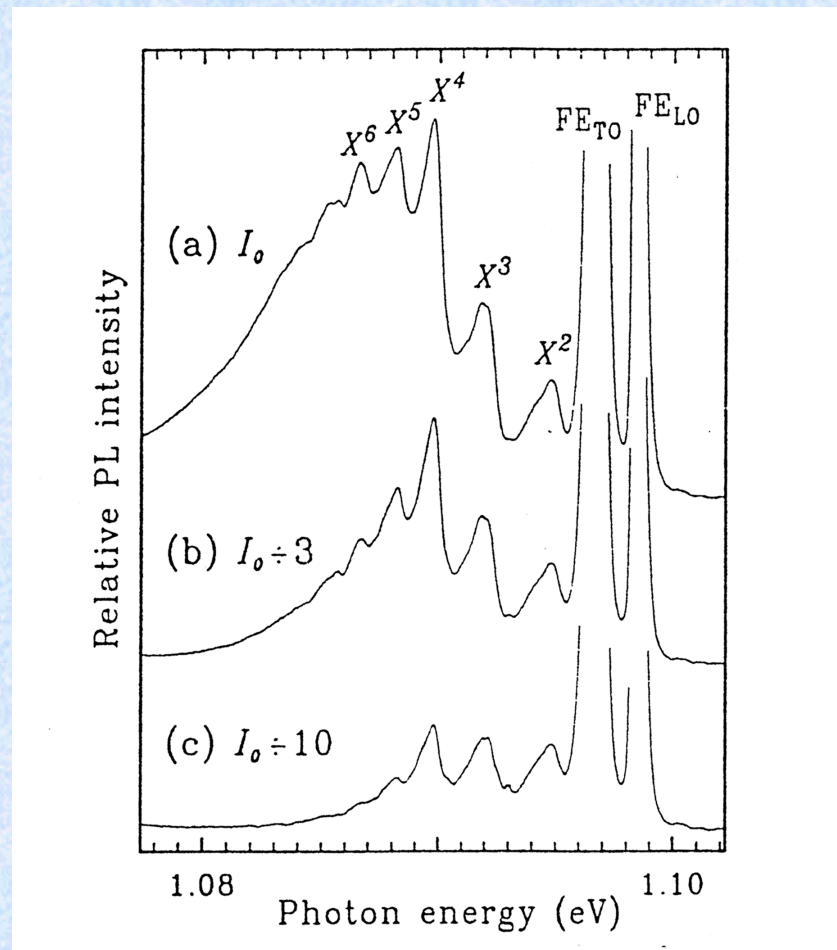

infrared luminescence of ultrapure Si, ICPS 23, Berlin 1996

other new results from low excitation ultrapure Si PL –
apparent changes in B concentration with thermal history?

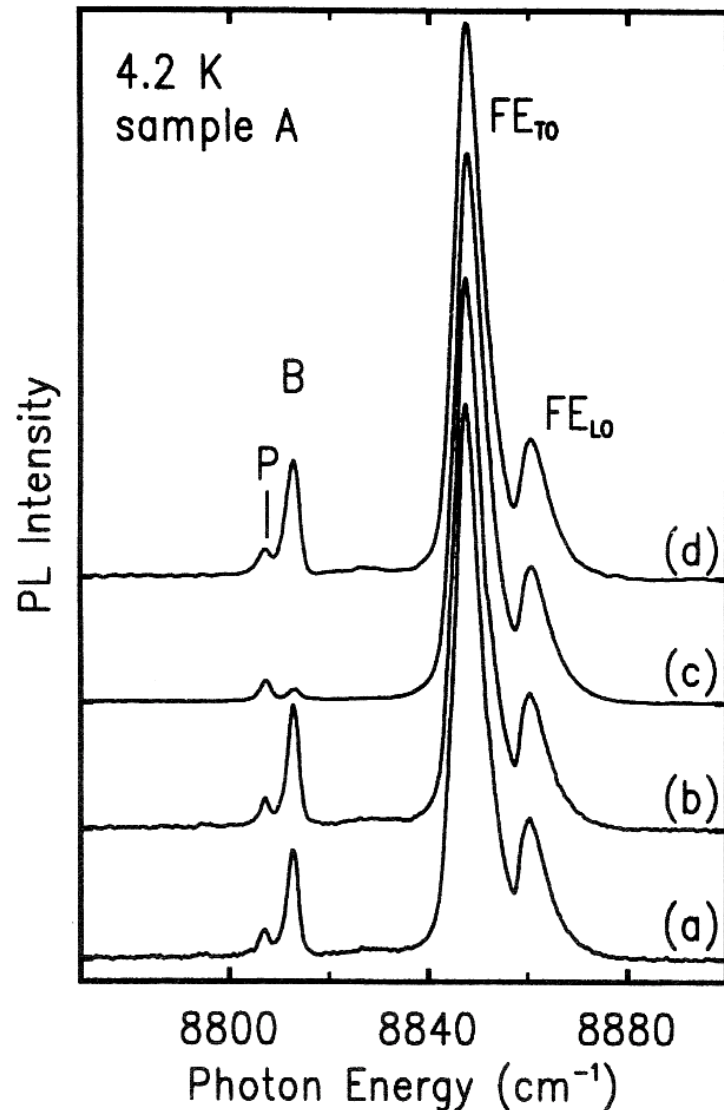

Fe_i-B pairs form, dissociate, remove B PL
sets a sensitive lower bound on [Fe_i]

I. Broussell et al., Appl. Phys. Lett. 78, 3070
(2001)

← sample (c) followed by (b) treatment

← quench from 300 C to RT followed
by anneal at 40 C

← slow cool from 150 C

← as received

Isotopically enriched Si

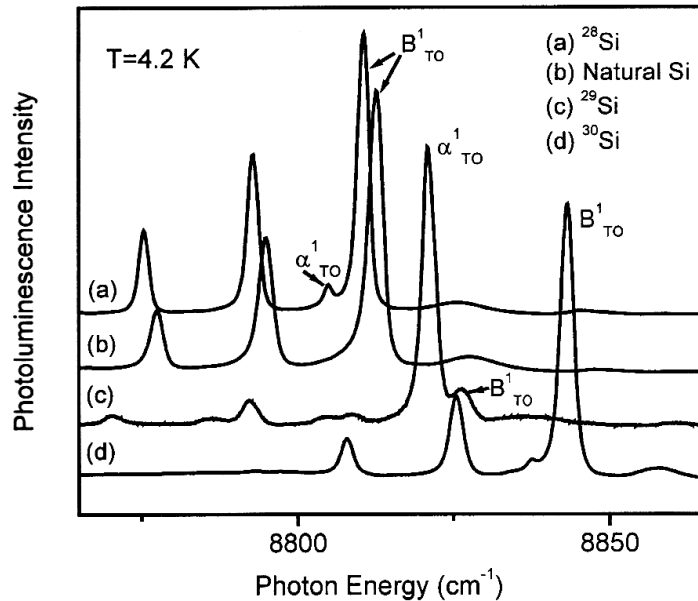

the same PL scans used to characterize impurity content can verify isotopic composition

the band gap shifts with \bar{M} ; the shifts can be determined from the BE_{NP} energies

phonon energies also change with \bar{M} , and these can be measured from PL

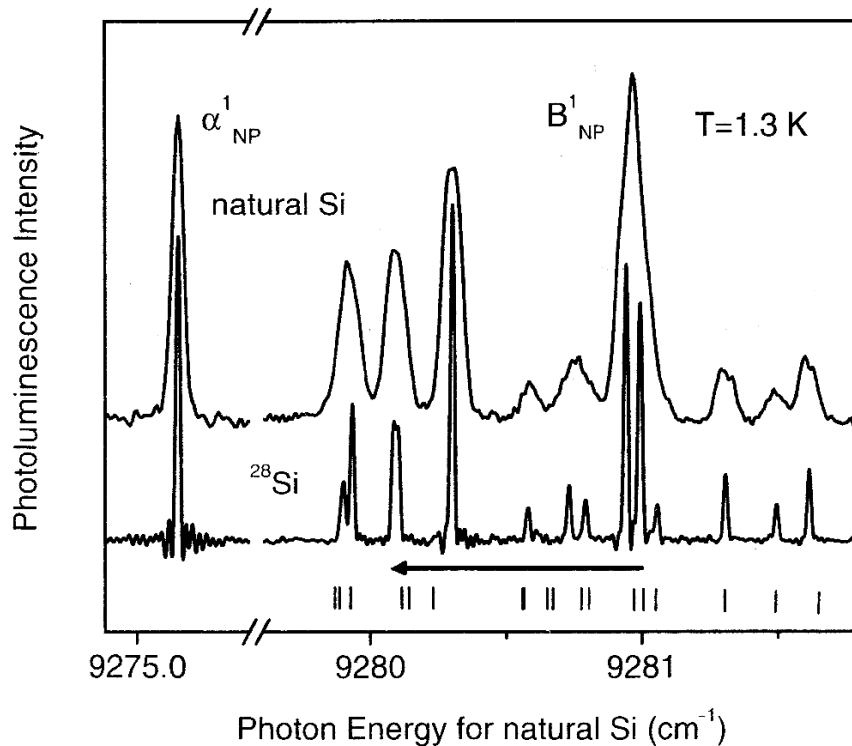

removal of the inhomogeneous broadening inherent in natural Si puts unprecedented demands on resolution

D. Karaiskaj et al., Phys. Rev. Lett. 86, 6010 (2001)

D. Karaiskaj et al., Solid State Commun. 123, 87 (2002)

High purity GaAs, T=1.8K, visible Ar-ion excitation

(note the strong effects of changing the excitation density)

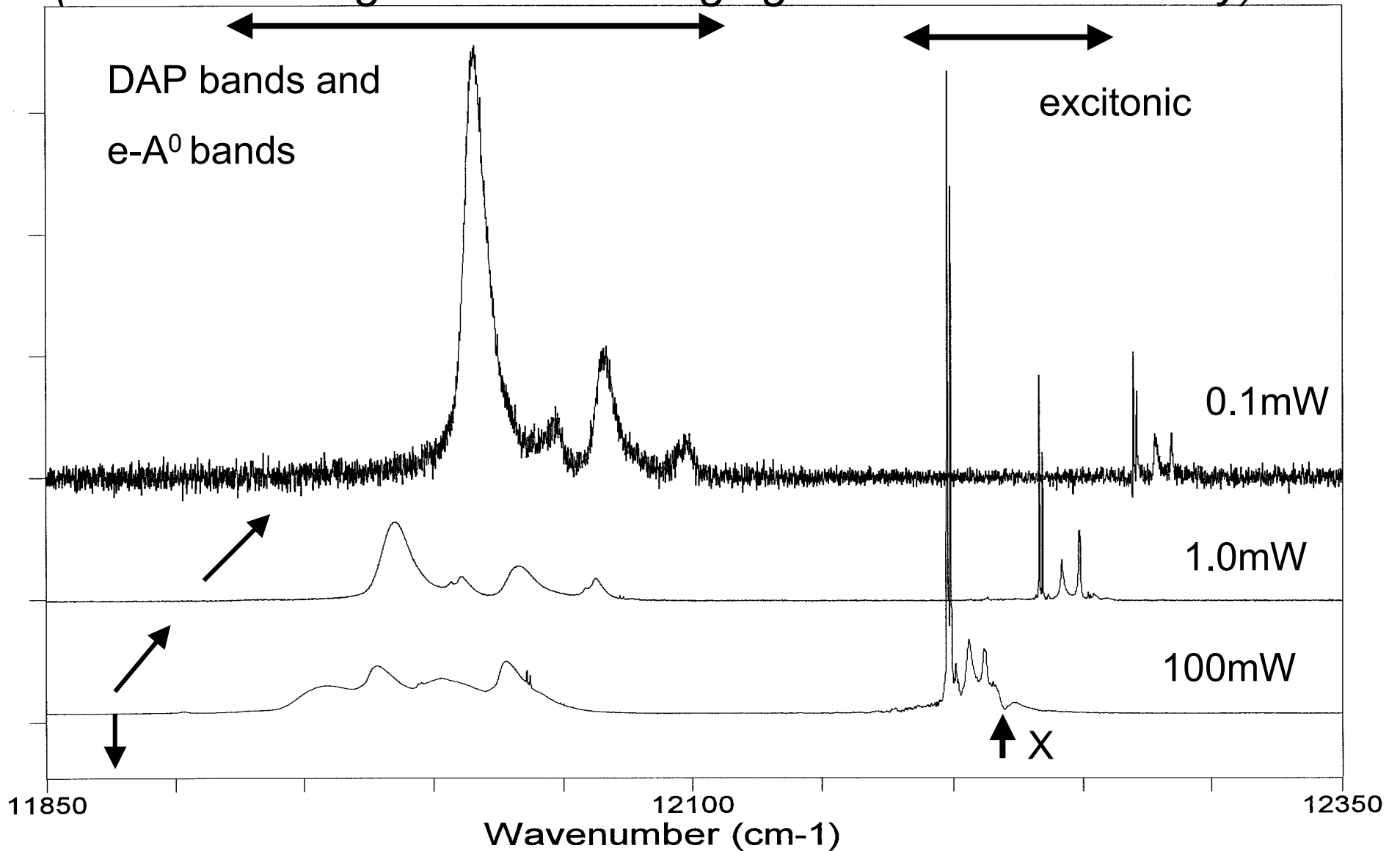

high purity GaAs – excitonic region

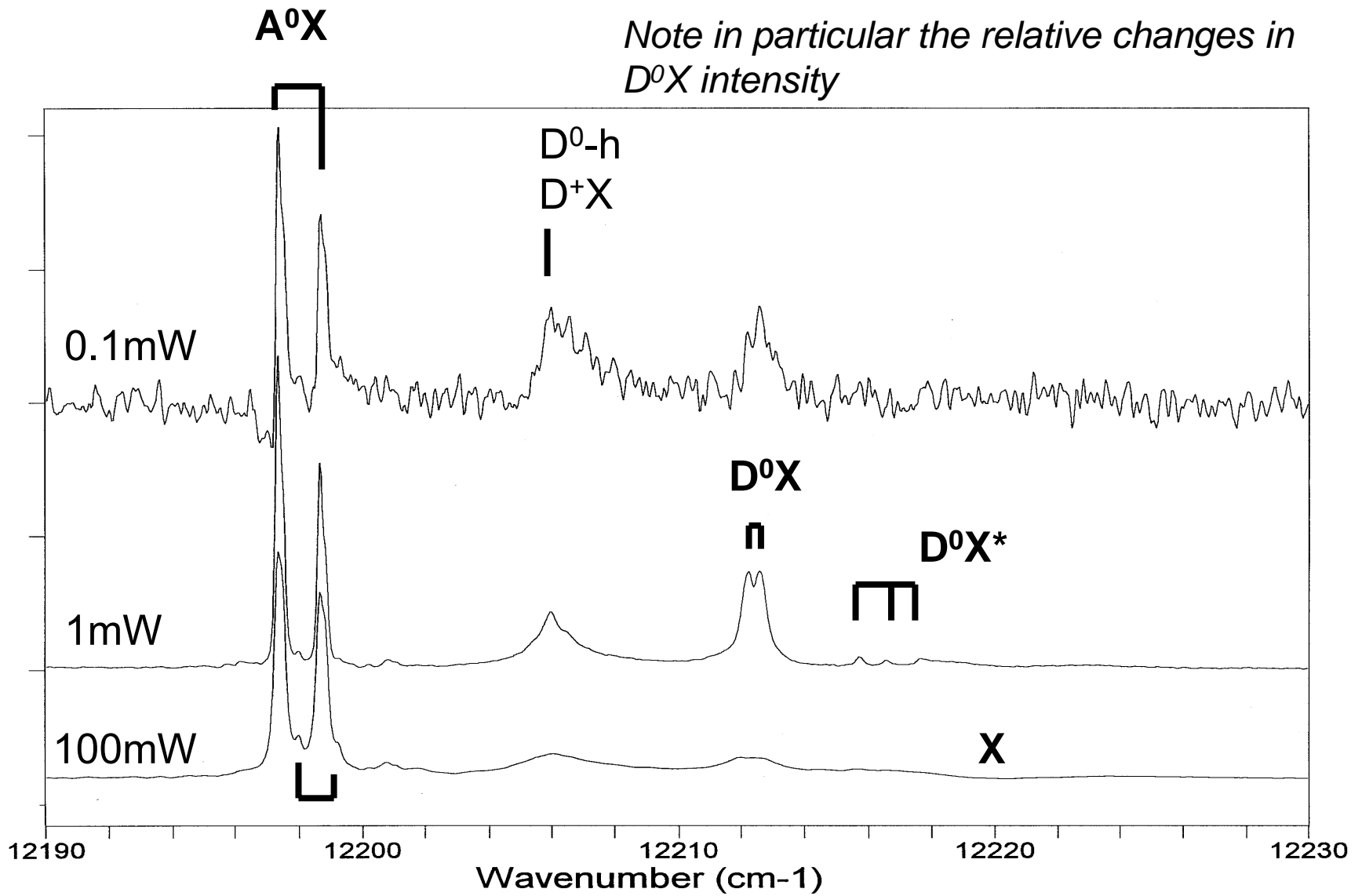

High purity GaAs DAP band and e-A⁰ band region

(note sharpening and shifting of DAP, decrease of e-A⁰ and THT's)

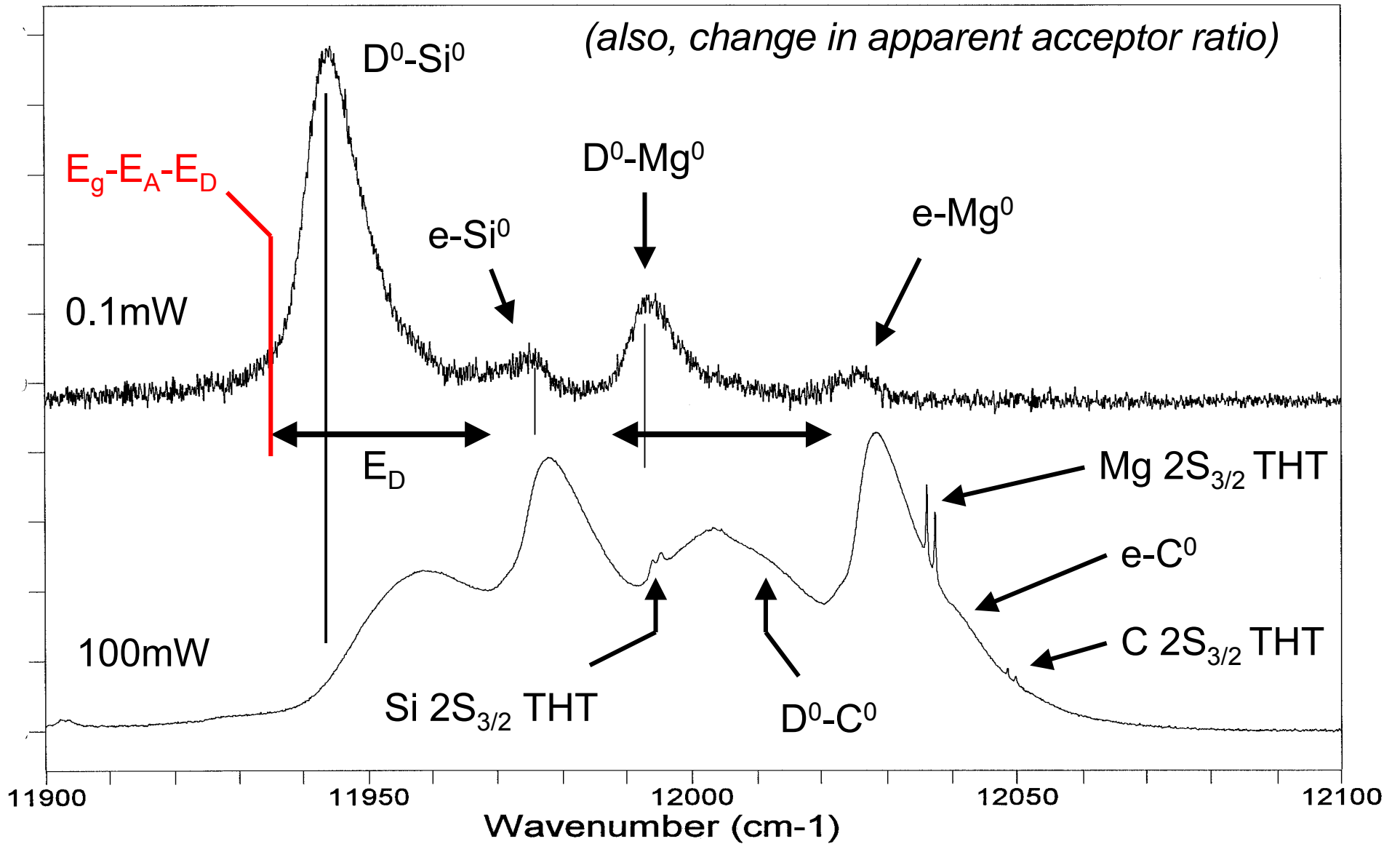

overcharged donor to neutral acceptor transitions

($D^- \rightarrow A^0$, no Coulomb energy)

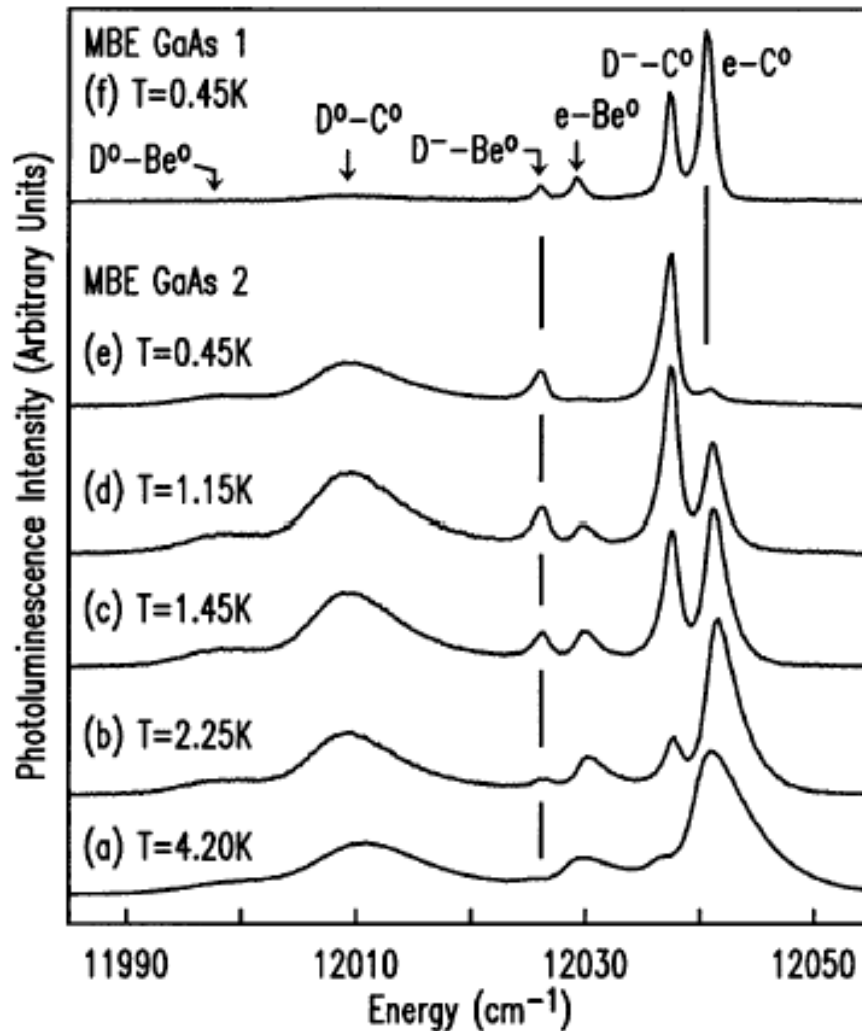

- a new type of PL transition
- a new way of studying D^-
- PRL 80, 2461 (1998)
- magnetic field studies –
- like H^- at megagauss fields
- PRB 60, 15527 (1999)

Relatively low quality bulk semi-insulating GaAs substrate

nonresonant Ar-ion excitation (high)

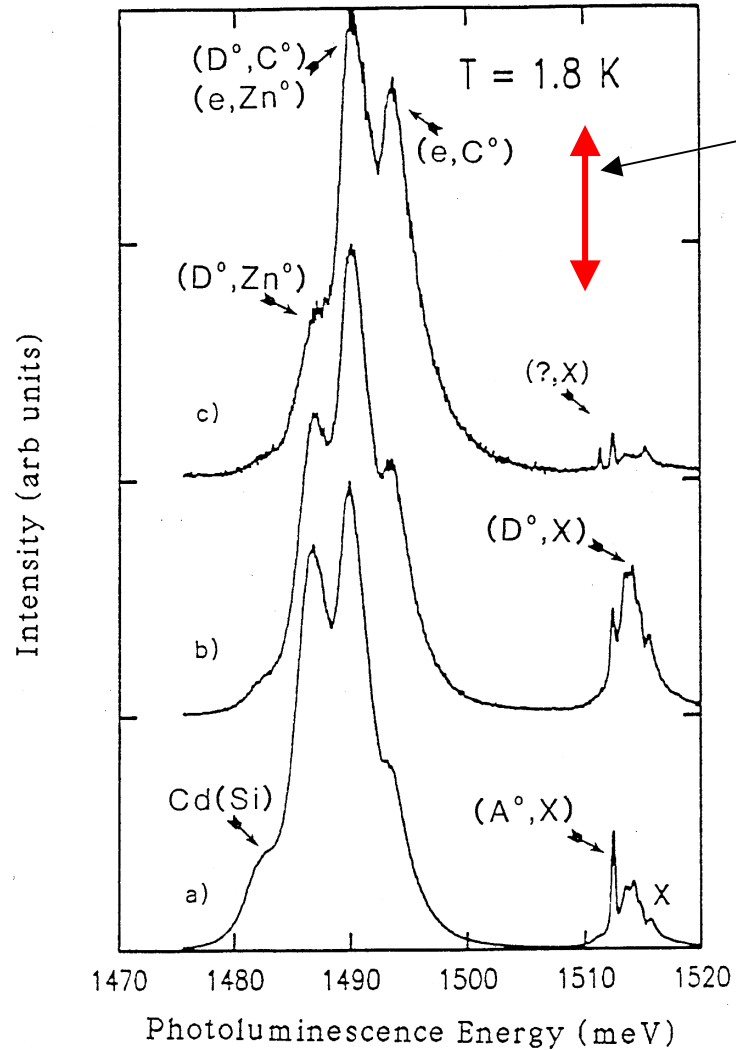

resonant SPL spectra

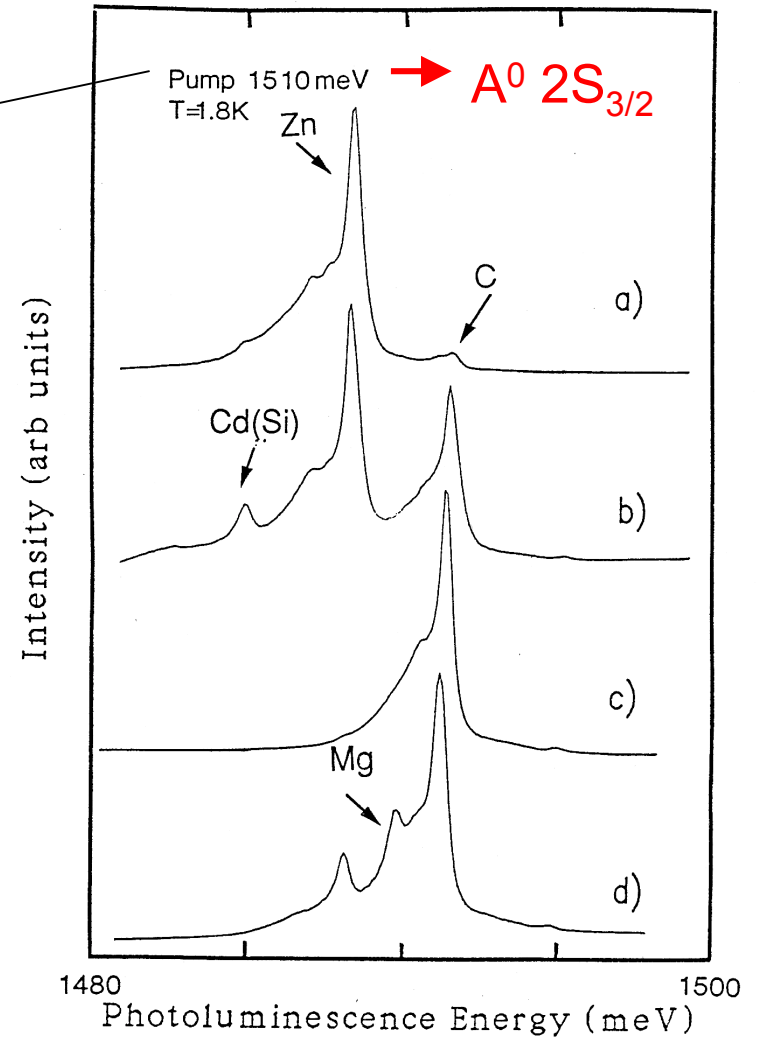

New physics resulting from characterization work on S.I. GaAs bulk substrate material – the EL2 defect

PL studies on these samples, together with the advantages provided by FT spectroscopy, revealed sharp new transitions of the important EL2 defect

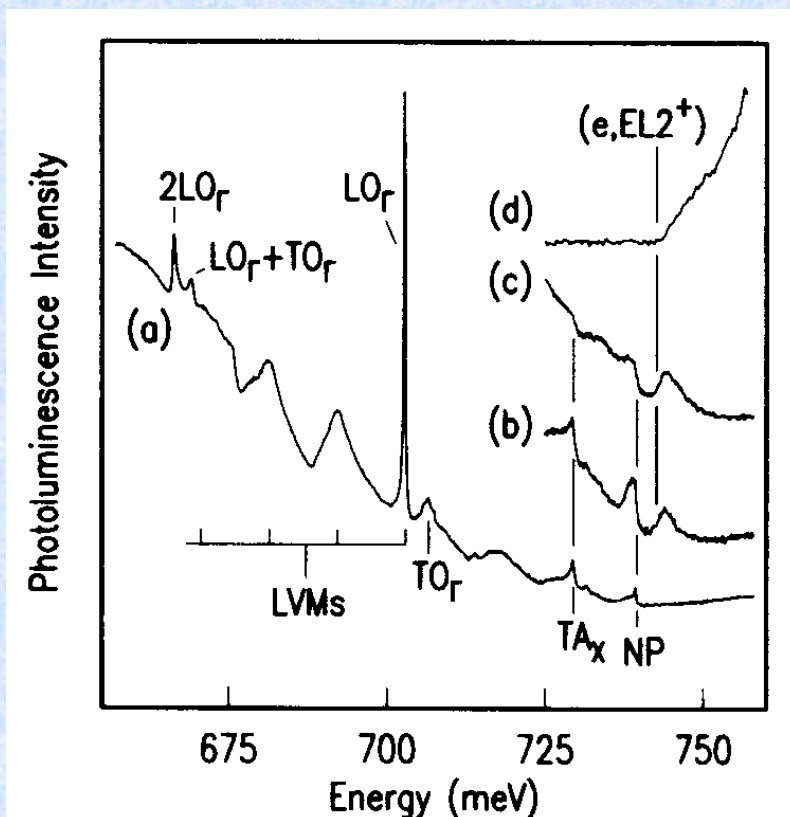

PRL 65, 2282 (1990)

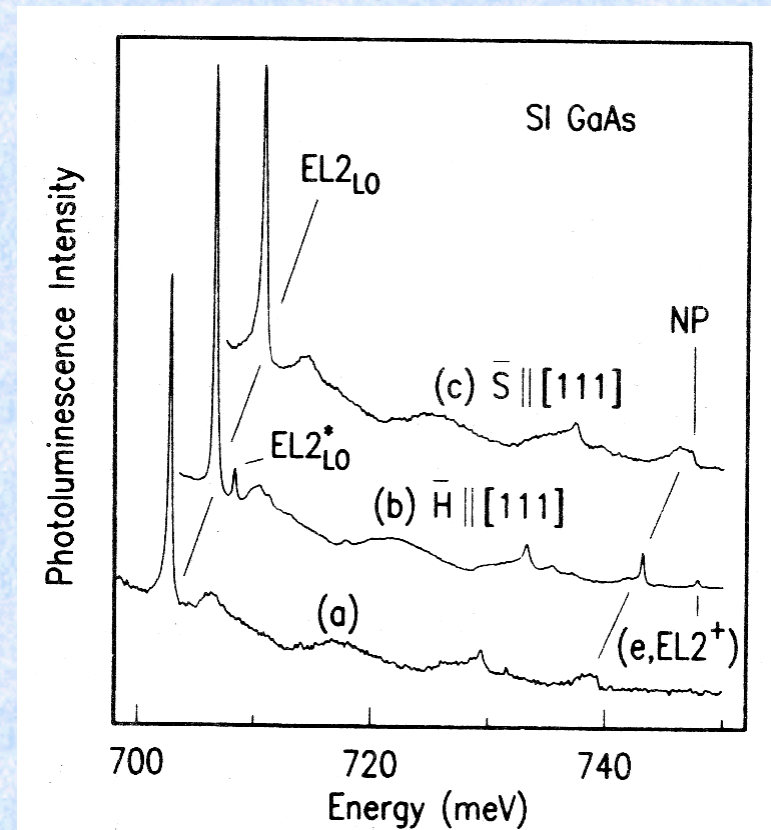

PRL 67, 112 (1991)

Donor identification in direct gap semiconductors: GaAs

This poses a challenge, since in direct gap materials the small m_e^* ($\sim 0.07m_0$ for GaAs) results in small donor binding energies, large Bohr radii, and small amplitude near the impurity ion, thus small chemical shifts.

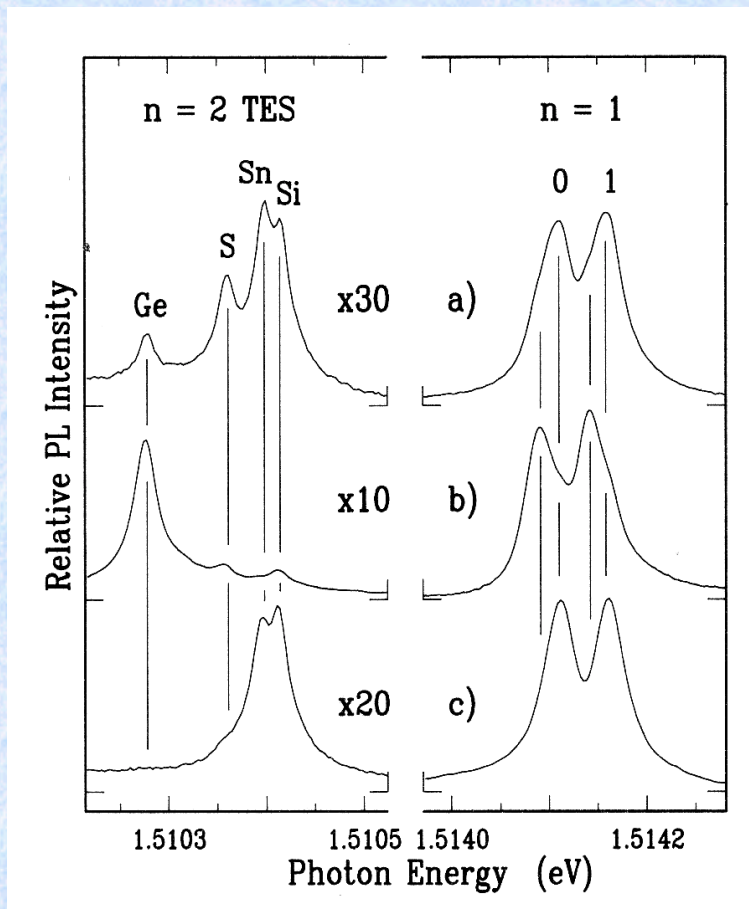

For high quality samples, chemical shifts are apparent in the D^0X principal ($n=1$) transitions, but are not adequate for characterization.

The $n=2$ D^0X two-electron transitions (TET or here TES) are adequate for donor identification, but only in high quality samples.

V. A. Karasyuk et al., Phys. Rev. B 49, 16381 (1994)

what about donor ID in low quality samples? magnetoPL

By applying a large (6T to 12T) magnetic field, the donor wavefunctions are compressed, and the chemical shifts increased. Also, linewidths are improved by removing near-degeneracies.

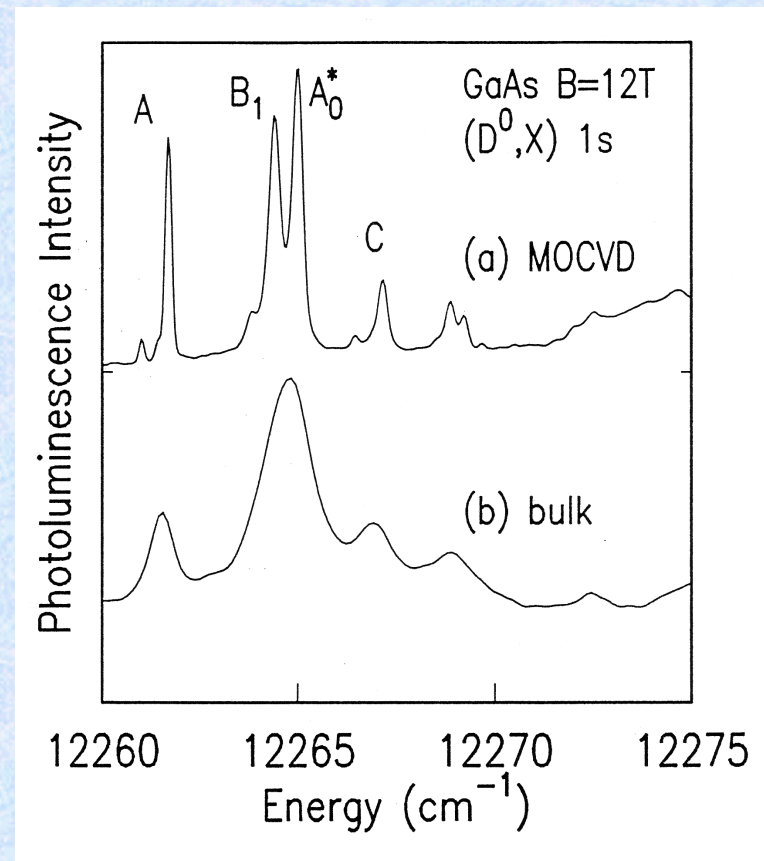
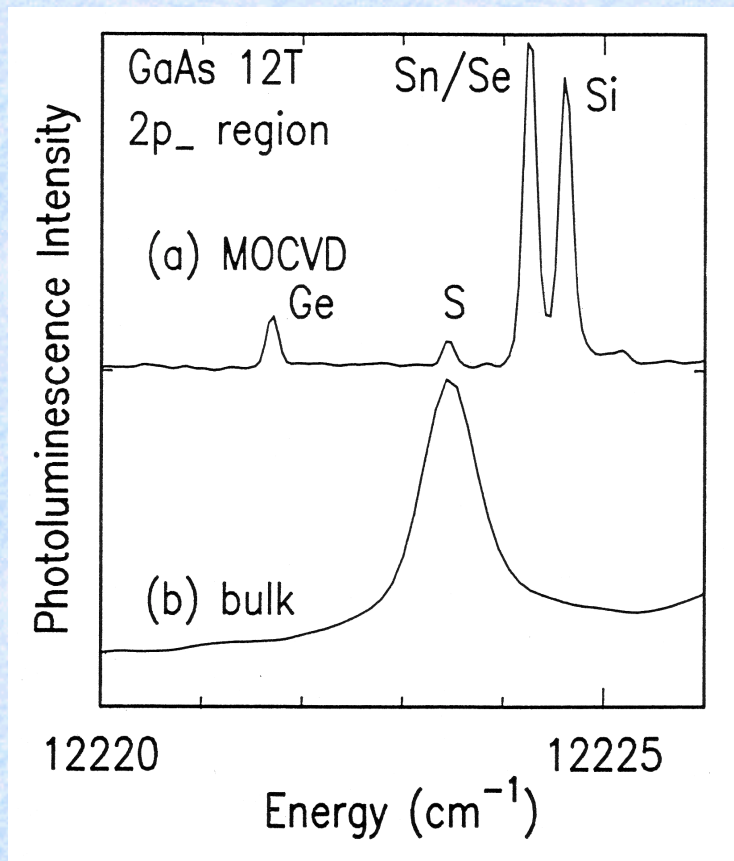

Faraday

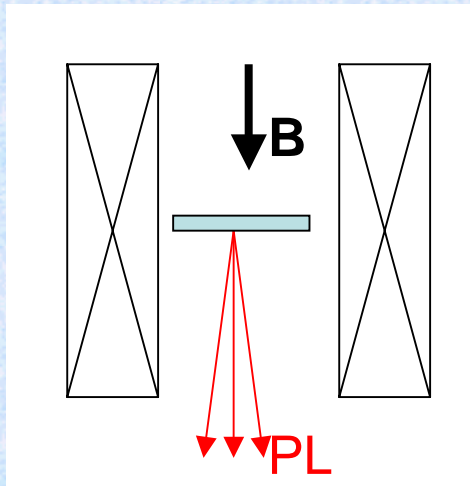

ease of
alignment
circular pol.
high B

Voigt

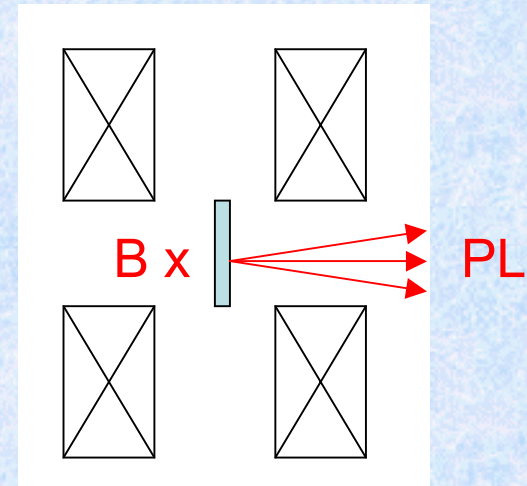

linear pol.
can do both

Further references:

B. J. Skromme et al., IEEE J. Quant. Electron. 25, 1035 (1989).

V. A. Karasyuk et al., Phys. Rev. B 49, 16381 (1994).

An alternate technique for donor ID involves far-infrared donor absorption spectroscopy, again usually in the presence of a large B field to enhance the chemical shifts, often done by monitoring the induced photocurrent (PTIS); see for example B. J. Skromme et al., J. App. Phys. 58, 4685 (1985).

^{75}GaP isotope study, $T=1.8\text{K}$, DAP band from C_p and S_p

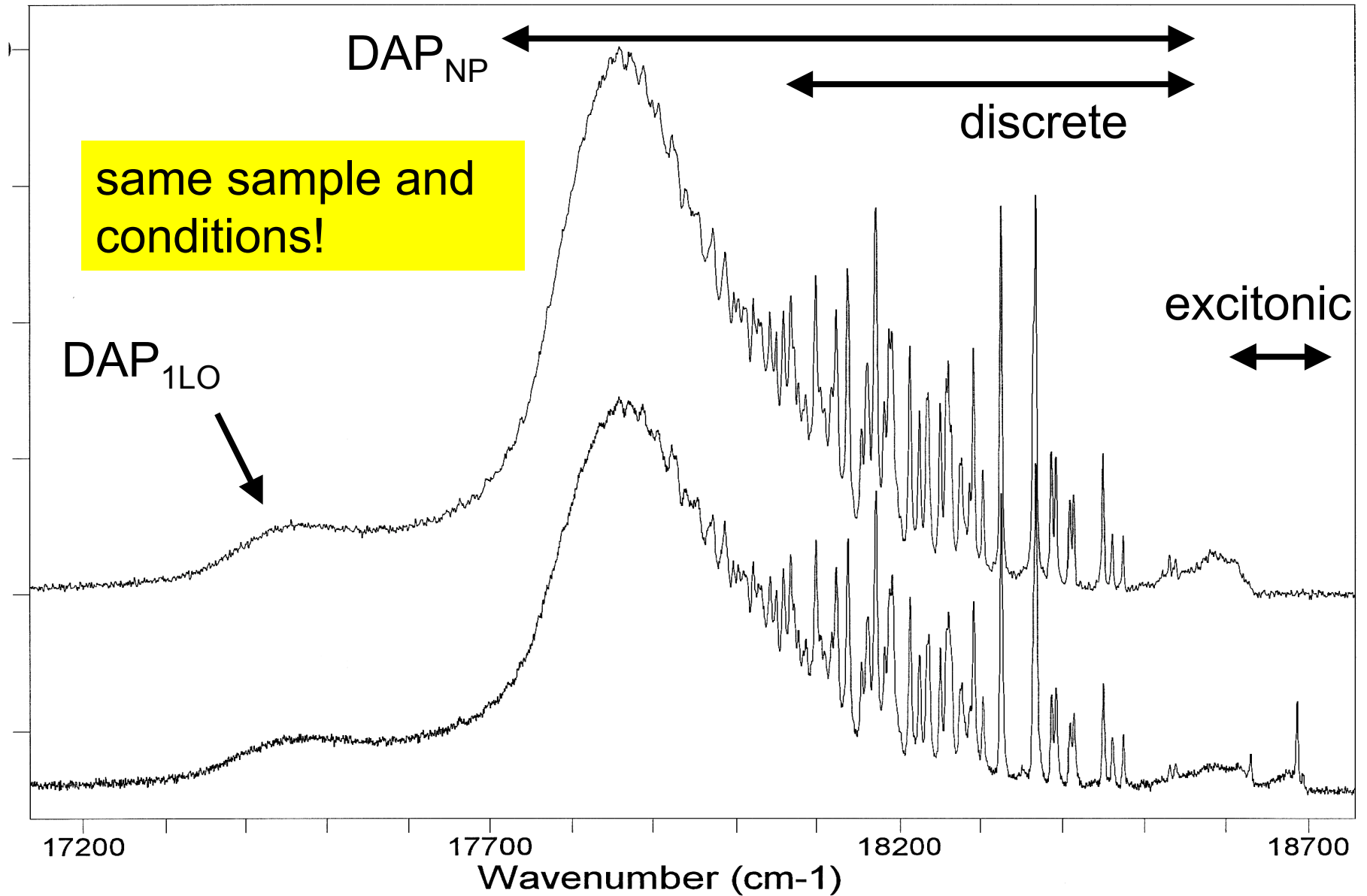

Characterization of pure, narrow-gap (direct) materials (here FT methods are essential)

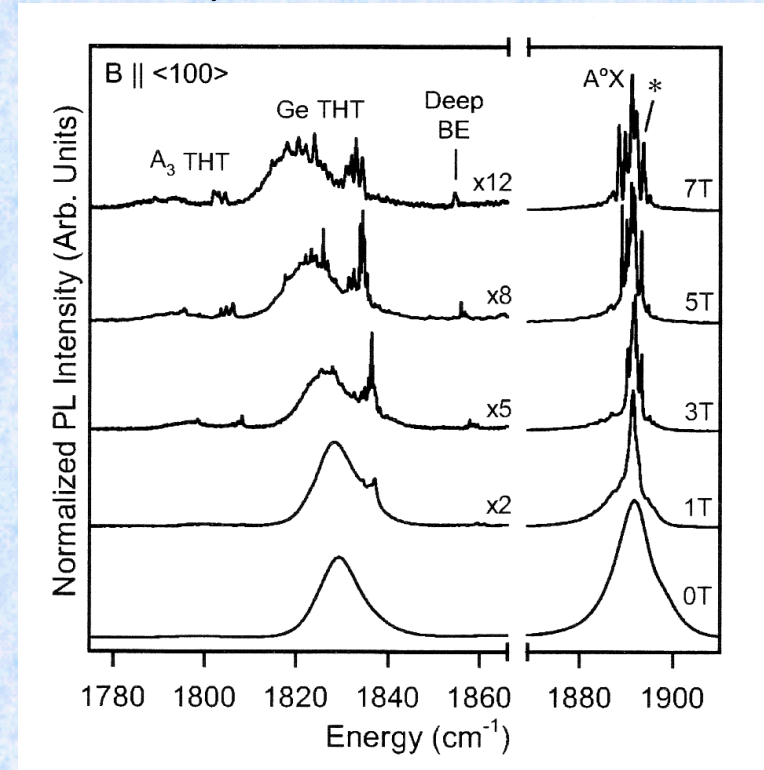
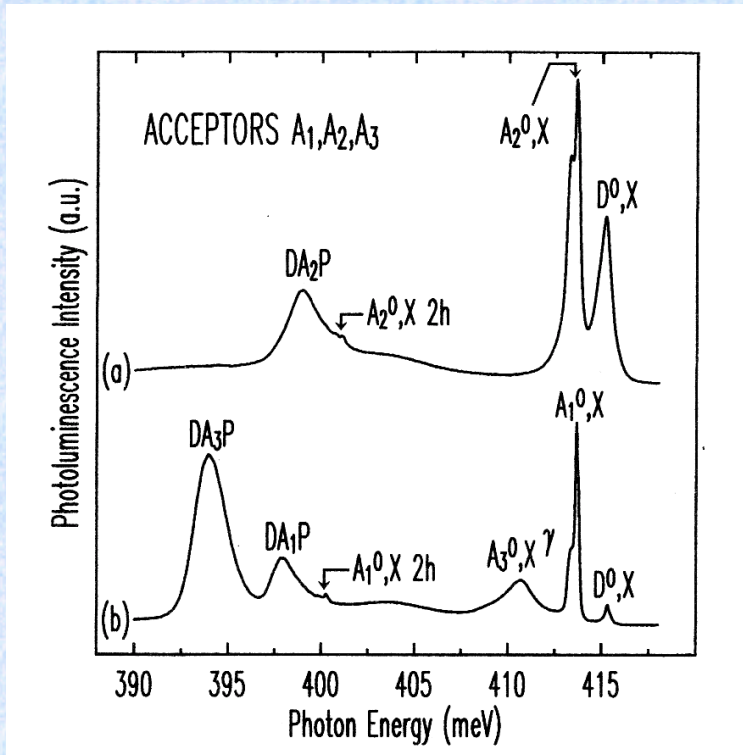

high purity epitaxial InAs

3 unidentified acceptors

Y. Lacroix et al., J. Appl. Phys.
80, 6416 (1996)

high purity bulk InSb

B field needed even for A^0X

Ge, Cd and unknown acceptor

J. A. H. Stotz and M. L. W. Thewalt,
Phys. Rev. B 67, 155210 (2003)

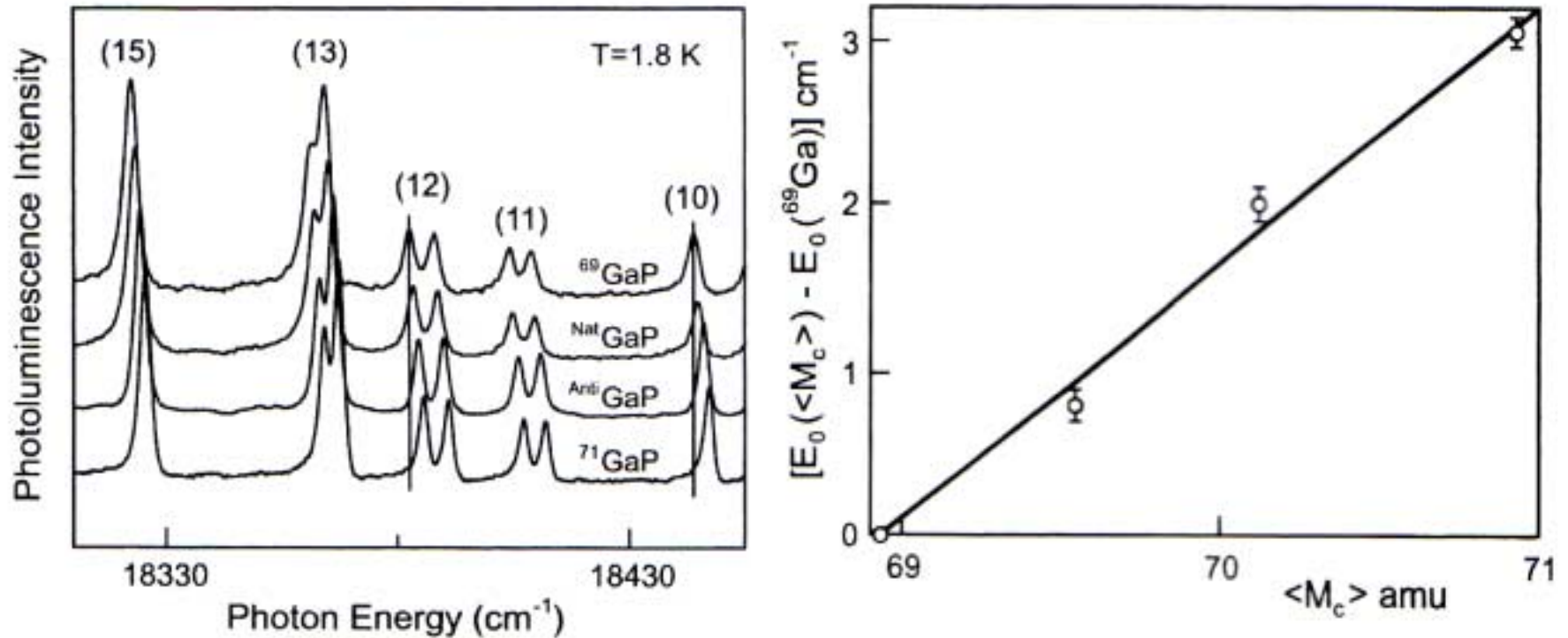

Since all four samples were dominated by the same $C_p - S_p$ DAP transitions, very accurate energy comparisons were possible.

(T. A. Meyer et al., Effect of the isotopic mass of gallium on the indirect gap of GaP, Solid State Commun. 126, 119 (2003))